

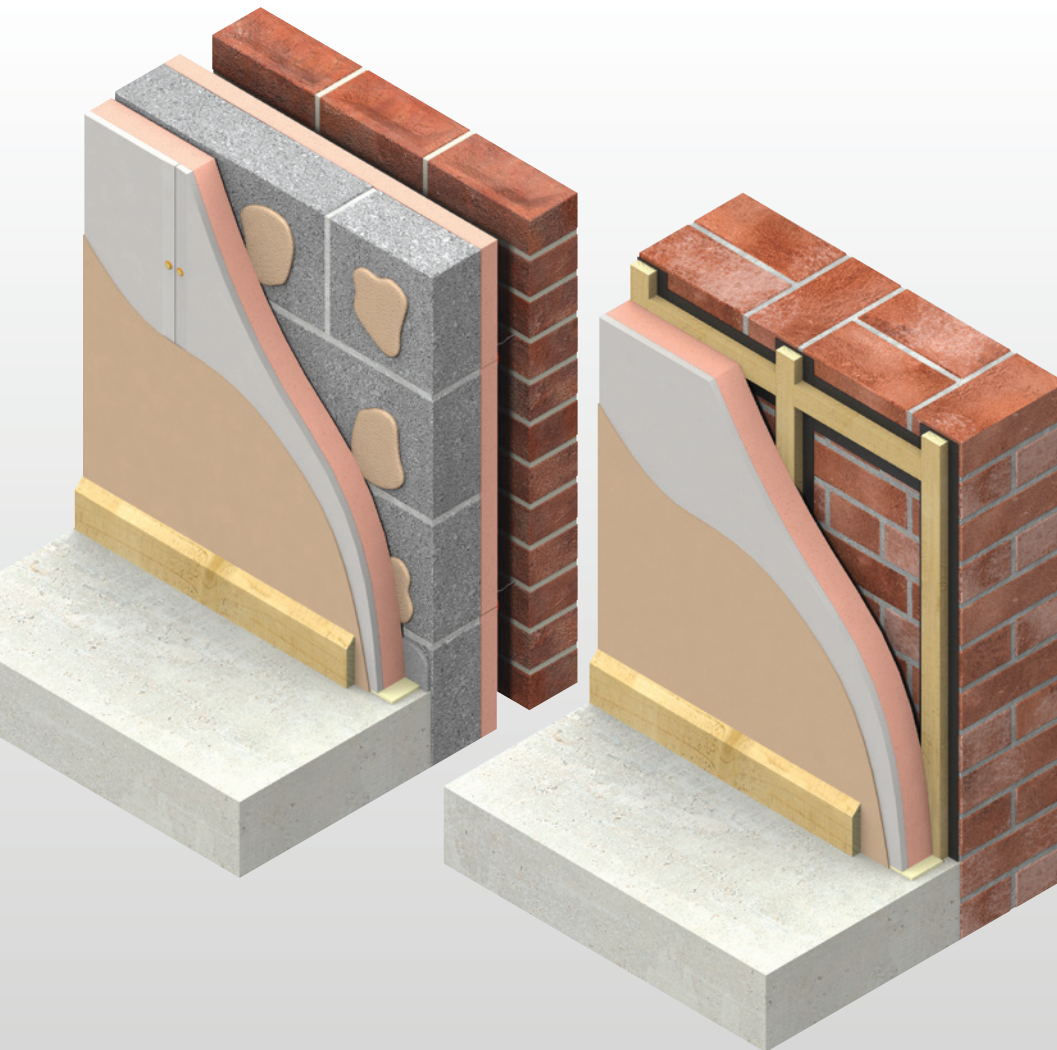

Kooltherm® K118 Insulated Plasterboard

INSULATED PLASTERBOARD FOR MECHANICALLY FIXED & ADHESIVELY BONDED INSULATED DRY-LINING



- Premium performance rigid thermoset phenolic insulation – thermal conductivity of 0.018 W/m·K
- Insulation, dry-lining and vapour control in one board
- Allows quick response heating
- Unaffected by air infiltration
- Resistant to the passage of water vapour
- Easy to handle and install
- Ideal for new build, retrofit and refurbishment
- Non-deleterious material
- Manufactured with a blowing agent that has zero ODP and low GWP



Low Energy –
Low Carbon Buildings

Typical Constructions and U-values

Assumptions

The U-values in the tables that follow have been calculated, under a management system certified to the BBA Scheme for Assessing the Competency of Persons to Undertake U-value and Condensation Risk Calculations, using the method detailed in BS EN ISO 6946: 2017 / I.S. EN ISO 6946: 2007 (Building components & building elements. Thermal resistance & thermal transmittance. Calculation methods), and using the conventions set out in BR 443 (Conventions for U-value calculations). They are valid for the constructions shown in the details immediately above each table.

These examples are based on the use of 3 mm skim coated **Kingspan Kooltherm® K118 Insulated Plasterboard** dot and dab bonded to the construction supplemented with appropriate secondary fixings, or mechanically fixed to both 25 x 47 mm treated softwood timber battens and metal studding / channels.

NB When calculating U-values to BS EN ISO 6946: 2017 / I.S. EN ISO 6946: 2007, the type of mechanical fixing used may change the thickness of insulation required. For the mechanically fixed options to timber battens or metal studding / channels, the use of carbon steel fasteners of cross sectional area 4 mm² has been assumed at a density of 16.7 per m².

NB The calculations for adhesively bonded applications assume the use of 2 appropriate secondary fixings per board for acrylic sealant and PU foam adhesive, and 6 appropriate secondary fixings per board for drywall adhesive. No correction factor for mechanical fixings has been taken into account as appropriate secondary fixings, such as nailable plugs or helical anchor fixings at a rate of 2 or 6 per board, do not have an adverse effect on U-values.

NB For the purposes of these calculations the standard of workmanship has been assumed good, and therefore the correction factor for air gaps has been ignored.

NB The figures quoted are for guidance only. A detailed U-value calculation and a condensation risk analysis should be completed for each project.

NB If your construction is different from those specified, and / or to gain a comprehensive U-value calculation along with a condensation risk analysis of your project, please consult the Kingspan Insulation Technical Service Department for assistance (see rear cover).

U-value Table Key

Where an **X** is shown, the U-value is higher than the worst of the maximum new build area weighted average U-values allowed by the:

- 2013 editions of Approved Documents L to the Building Regulations for England;
- 2014 editions of Approved Documents L to the Building Regulations for Wales;
- 2015 editions of Technical Handbooks Section 6 to the Building Standards for Scotland;
- 2012 editions of Technical Booklets F1 & F2 to the Building Regulations for Northern Ireland; and
- 2011 edition of Technical Guidance Document L (Dwellings) and 2008 edition of Technical Guidance Document L (Buildings other than Dwellings) to the Building Regulations for the Republic of Ireland.

Where an **♦** is shown, the combination of insulation products may result in an interstitial condensation risk and so the calculations have been excluded.



Solid Masonry Walls

Solid Brickwork

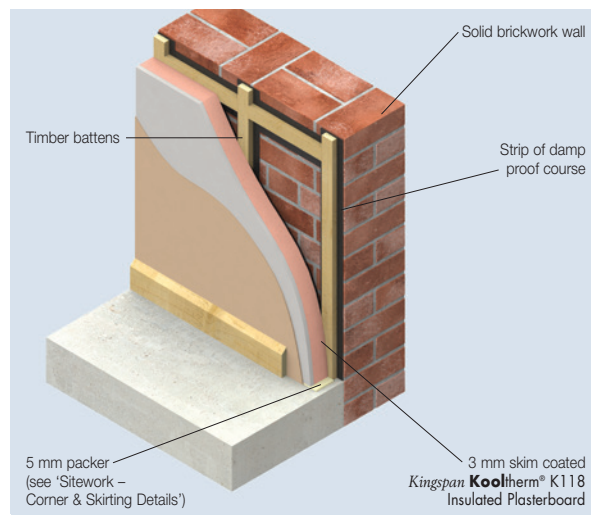

Figure 1

U-values (W/m²·K) for Various Product Thicknesses of **Kingspan Kooltherm® K118 Insulated Plasterboard** and Different Fixing Methods

Product Thickness* (mm)	Brickwork Thickness	
	102.5 mm	215 mm
Timber Battens at 600 mm centres		
52.5	0.34	0.33
57.5	0.32	0.30
62.5	0.29	0.28
67.5	0.27	0.26
72.5	0.26	0.25
82.5	0.23	0.22
87.5	0.22	0.21
92.5	0.21	0.20
102.5	0.19	0.18
112.5	0.17	0.17
122.5	0.16	0.15
Metal Studding / Channels at 600 mm centres		
52.5	X	0.34
62.5	0.31	0.29
67.5	0.28	0.27
72.5	0.27	0.26
82.5	0.24	0.23
87.5	0.22	0.22
92.5	0.21	0.21
102.5	0.19	0.19
112.5	0.18	0.17
122.5	0.16	0.16

* Product thickness = insulant thickness + 12.5 mm plasterboard.

NB Refer to local distributor or Kingspan Insulation price list for current stock and non-stock sizes.

Solid Brickwork with Existing Lining

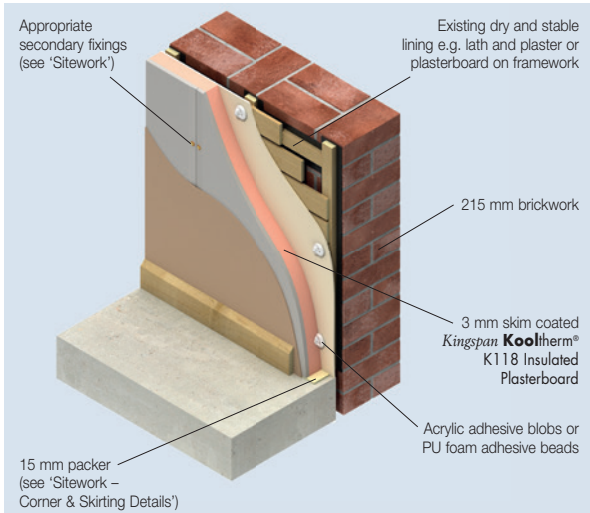

Figure 2

Kooltherm® K118 Insulated Plasterboard Product Thickness* (mm)	U-values (W/m ² -K)
32.5	X
37.5	X
42.5	X
52.5	0.34
57.5	0.31
62.5	0.29
72.5	0.25
82.5	0.22
87.5	0.20
92.5	0.19

* Product thickness = insulant thickness + 12.5 mm plasterboard.
 NB Refer to local distributor or Kingspan Insulation price list for current stock and non-stock sizes.

Solid Stonework

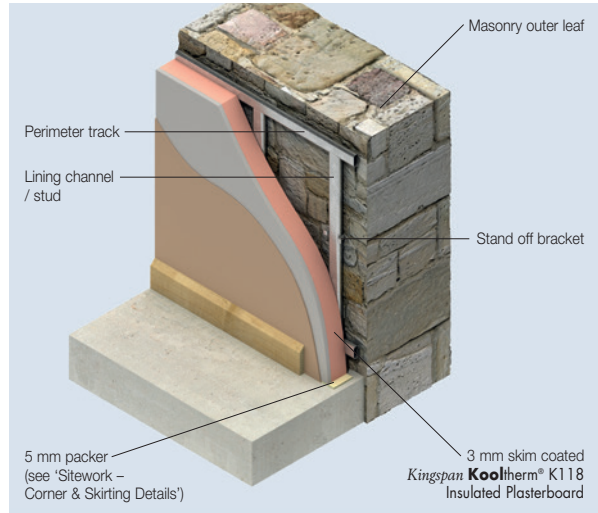

Figure 3

U-values (W/m²-K) for Various Product Thicknesses of Kingspan Kooltherm® K118 Insulated Plasterboard and Different Fixing Methods

Product Thickness* (mm)	Thickness of Stonework	
	300 mm Sandstone**	450 mm Sandstone**
Timber Battens at 600 mm centres		
52.5	0.34	0.33
57.5	0.32	0.31
62.5	0.29	0.29
67.5	0.27	0.27
72.5	0.26	0.25
82.5	0.23	0.22
87.5	0.22	0.21
92.5	0.21	0.20
102.5	0.19	0.18
112.5	0.17	0.17
122.5	0.16	0.16
Metal Studding / Channels at 600 mm centres		
52.5	X	0.35
57.5	0.33	0.32
62.5	0.31	0.30
67.5	0.28	0.28
72.5	0.27	0.26
82.5	0.24	0.23
87.5	0.22	0.22
92.5	0.21	0.21
102.5	0.19	0.19
112.5	0.18	0.17
122.5	0.16	0.16

* Product thickness = insulant thickness + 12.5 mm plasterboard.
 ** Calculations assume sandstone stonework of λ -value (2.30 W/m-K).
 NB Refer to local distributor or Kingspan Insulation price list for current stock and non-stock sizes.

Typical Constructions and U-values

Masonry Cavity Walls

102.5 mm Brick Outer Leaf / Cavity / 100 mm Block Inner Leaf

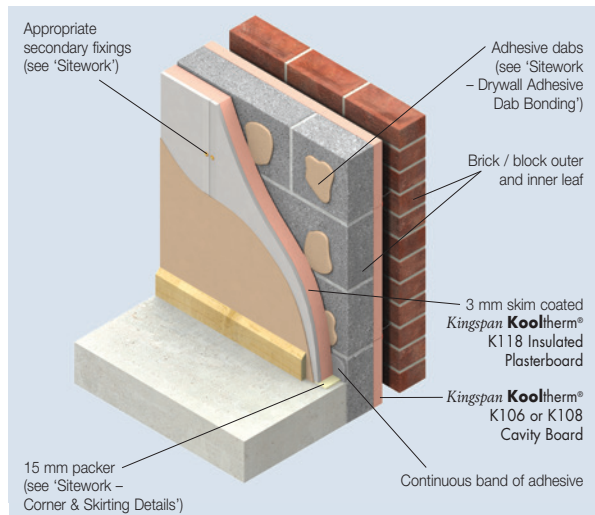

Figure 4

U-values (W/m ² ·K) for Various Product Thicknesses of Kingspan Kooltherm® K118 Insulated Plasterboard and Thicknesses of Kingspan Kooltherm® K108 Cavity Board						
Kooltherm® K118 Product Thickness* (mm)	Inner Leaf Blockwork Density and λ-value (W/m·K)				Thin Joint Aerated	
	Dense (1.13)	Medium (0.51)	Lightweight (0.15)**	Aerated (0.11)**	(0.11)***	
Clear / Hard to Treat Cavity						
37.5	X	X	X	0.34	0.33	
42.5	X	X	X	0.31	0.31	
47.5	0.35	0.34	0.30	0.28	0.28	
52.5	0.32	0.31	0.28	0.26	0.26	
57.5	0.29	0.28	0.26	0.25	0.24	
62.5	0.27	0.26	0.24	0.23	0.23	
72.5	0.23	0.23	0.21	0.20	0.20	
82.5	0.21	0.20	0.19	0.18	0.18	
87.5	0.20	0.19	0.18	0.17	0.17	
92.5	0.19	0.18	0.17	0.17	0.17	
100 mm Cavity Partially Filled with 50 mm of Kingspan Kooltherm® K108 Cavity Board†						
32.5	0.19	0.18	0.17	0.17	0.17	
37.5	0.18	0.18	0.17	0.16	0.16	
42.5	0.17	0.17	0.16	0.15	0.15	
52.5	0.16	0.15	0.15	0.14	0.14	
62.5	0.14	0.14	0.13	0.13	0.13	
67.5	🔵	🔵	🔵	🔵	🔵	
100 mm Cavity Partially Filled with 60 mm of Kingspan Kooltherm® K108 Cavity Board†						
32.5	0.17	0.17	0.16	0.15	0.15	
37.5	0.16	0.16	0.15	0.15	0.15	
42.5	0.16	0.15	0.15	0.14	0.14	
52.5	0.14	0.14	0.13	0.13	0.13	
62.5	0.13	0.13	0.12	0.12	0.12	

Linear Thermal Bridging at Junctions

Basic Principles

Linear thermal bridging describes the heat loss at junctions between elements, which is additional to the losses occurring through roofs, walls and floors. This heat loss is represented by the junction's psi (Ψ) value. The lower the Ψ -value, the better the performance of a junction detail. The Ψ -values and lengths of linear thermal bridges are accounted for in a new building's energy and carbon dioxide emissions calculations. Existing building junction losses are not typically accounted for in whole building heat loss calculations and only the risk of surface condensation and mould growth are considered.

Heat typically flows through the easiest path, for example in a masonry cavity wall the linear thermal bridge is primarily the inner leaf of masonry and in a timber frame wall the linear thermal bridge is primarily the sole plate and the construction below it. These linear thermal bridges can be reduced by increasing the distance that the heat has to travel.

Whilst there are some 'approved' details available, they are specifically targeted at new build constructions. However, where applicable, they are also considered good practice for refurbishment.

* Product thickness = insulant thickness + 12.5 mm plasterboard.
 ** A 6.6% thermal bridging factor has assumed for the effect of mortar joints.
 *** A 1.4% thermal bridging factor has assumed for the effect of mortar joints.
 † Please read the section entitled 'Residual Cavity Width' in the literature for Kingspan Kooltherm® K108 Cavity Board for details of cavity width requirements in the UK and Ireland.
 NB Refer to local distributor or Kingspan Insulation price list for current stock and non-stock sizes.

Design Considerations

Reducing Linear Thermal Bridging

Detailing at junctions to minimise the effects of thermal bridging and the associated risk of condensation or mould growth is important and there are some simple design considerations that can be adopted when insulating internally to help mitigate the risks and to reduce heat loss.

At a window or door opening, the primary linear thermal bridge is the reveal. This heat loss can be reduced by insulating the reveal. The key factor is the thermal resistance (R-value) of the insulation layer. Reveals should be designed to accommodate 32.5 mm (min.) of **Kingspan Kooltherm® K118 Insulated Plasterboard**.

The application of internal insulation above and below an intermediate floor reduces the overall heat loss, but can increase the losses through the intermediate or separating floor. To reduce these losses, where possible, the edge of the intermediate floor within the floor void should also be insulated.

Where the properties to both sides of a party wall are to be insulated, best practice to minimise heat losses through the junction with external walls would be to return the insulation back along the party wall for at least 400 mm back from the external wall.

NB Where insulating the external walls to only one side of a party wall, and the other property remains uninsulated, it is better not to insulate back along the return, as this can increase the losses to the uninsulated side, increasing the risk of surface condensation and mould growth for the uninsulated property.

For further advice on details to reduce linear thermal bridging please contact the Kingspan Insulation Technical Service Department (see rear cover for details).

Responsible Sourcing

Kingspan Kooltherm® K118 Insulated Plasterboard produced at Kingspan Insulation's Pembridge manufacturing facility is certified to BES 6001 (Framework Standard for the Responsible Sourcing of Construction Products) 'Excellent'.

NB The above information is correct at the time of writing. Please confirm at the point of need by contacting Kingspan Insulation's Technical Service Department (see rear cover), from which a copy of Kingspan Insulation's BES 6001 certificate can be obtained.



Sustainability & Responsibility

Kingspan Insulation has a long-term commitment to sustainability and responsibility: as a manufacturer and supplier of insulation products; as an employer; as a substantial landholder; and as a key member of its neighbouring communities.

A report covering the sustainability and responsibility of Kingspan Insulation Ltd's British operations at its Pembridge, Herefordshire and Selby, North Yorkshire manufacturing facilities is available at www.kingspaninsulation.co.uk/sustainabilityandresponsibility.

Specification Clause

Kingspan Kooltherm® K118 Insulated Plasterboard should be described in specifications as:-

The wall dry-lining insulation shall be **Kingspan Kooltherm® K118 Insulated Plasterboard** ___ mm thick: comprising a premium performance rigid thermoset fibre-free phenolic insulation core with 12.5 mm plasterboard bonded to its front surface and a low emissivity composite foil facing on its reverse surface. The product shall have a thermal conductivity of 0.018 W/m.K. The product shall be manufactured: with a blowing agent that has zero Ozone Depletion Potential (ODP) and low Global Warming Potential (GWP); under a management system certified to ISO 9001: 2015, ISO 14001: 2015; BS OHSAS 18001: 2007 and ISO 50001: 2011; by Kingspan Insulation Limited; and installed in accordance with the instructions issued by them.

NBS Specifications

Details also available in NBS Plus.

NBS users should refer to clause(s):

K10 145, K10 155, K10 165,

K10 175, K10 205, K10 415

(Standard and Intermediate)

K10 15, K10 35, K10 41 (Minor Works)



Design Considerations

Design Standards

BS 8212: 1995 (Code of practice for dry lining and partitioning using gypsum plasterboard) should be considered.

Fixing Methods

Kingspan Kooltherm® K118 Insulated Plasterboard can be installed utilising either mechanical fixing or adhesive techniques.

Limitations

Kingspan Kooltherm® K118 Insulated Plasterboard has a gypsum plasterboard face. It should, therefore, not be used to isolate dampness, nor be used in continuously damp or humid conditions.

When fixing *Kingspan Kooltherm*® K118 Insulated Plasterboard to walls, the boards are normally fixed with their long edges vertical. Boards may be fixed horizontally with an increased number of timber noggins, metal fixing straps or fixing T's. For ceilings, the boards must be installed with the long edge running perpendicular to the joists or rafters (see 'Sitework – Mechanical Fixing – To Timber Framing Studs / Battens').

Fire Stops

Current Building Regulations / Standards should be considered with regard to the requirements for and provision of fire stops.

Water Vapour Control / Condensation

Consideration should be given to the risk of condensation, when designing thermal elements.

When internally lining a construction with insulation, condensation can be controlled by ensuring there is a layer of high vapour resistance on the internal surface of the construction. *Kingspan Kooltherm*® K118 Insulated Plasterboard contains an integral vapour control layer and, when installed correctly, with appropriate detailing at joints between sheets, penetrations and wall perimeters, can provide the necessary vapour resistance. If required, the vapour resistance of the wall lining can be increased by the application of two coats of Gyproc Drywall Sealer.

A condensation risk analysis should be carried out following the procedures set out in BS 5250: 2011 + A1: 2016 (Code of practice for control of condensation in buildings). The Kingspan Insulation Technical Service Department (see rear cover) can provide this service.

Sitework

Preparation

- The existing structure should be surveyed to ensure the construction is capable of supporting the weight of the internal wall system, ancillary items and any post-installation fittings.
- Existing wallpaper, skirting, picture rails, gloss paint and projecting window boards may need to be removed. Some internal finishes, such as vinyl wallpaper or gloss paint, can be scored or sanded as an alternative method to removal.
- The wall surface should be clean, stable and free from dust, contamination and loose or friable materials.
- The amount of preparation and removal required will be dependent on the chosen internal wall system.
- Check the structure is dry. Remedial work should be undertaken to remove dampness before installation of the internal wall insulation. Internal wall insulation must not be used to isolate dampness.
- Ensure there are no gaps at the perimeter (including floors, ceilings, internal corners or junctions), or around openings or service penetrations. For optimum airtightness, existing gaps should be sealed using a continuous fillet of drywall adhesive or flexible sealant, before wall lining commences.
- Positions for all new services should be determined. Existing services should be assessed to determine any alterations that may need to be made, for example relocating sockets and switches. Wall mounted fixings, such as electrical sockets, should be fitted to take into account the additional wall lining thickness.
- New wall linings must be designed to accommodate the thickness of the new insulated dry lining solution, particularly at reveals, heads, sills and in relation to ceiling height.

Mechanical Fixing

To Timber Framing Studs / Battens

- This method may be used on timber frame constructions or on dry, stable constructions capable of supporting battens and associated fixings. Timber battens can be packed out using proprietary shims to correct alignment and provide a space to accommodate services.
- Guidelines should be marked out at maximum 600 mm centres to indicate the positioning of the vertical battens.
- Vertical timber framing studs / battens should be set at maximum 600 mm horizontal centres, around the perimeter of the walls, at floor and ceiling, and around any openings and services which penetrate the system.
- If fixing to battens, they should be mechanically fixed to the wall, and comprise 25 x 47 mm (min.) treated softwood, backed with a strip of damp proof course (DPC).
- Each sheet of *Kingspan Kooltherm*® K118 Insulated Plasterboard should lap timber framing studs / battens / noggins by 19 mm (min.) at sheet joints.
- Battens should be fixed approximately 75 mm from the ends of each timber batten and positioned at a maximum 600 mm apart.
- Where joints between sheets of insulated plasterboard are unsupported by the timber framing studs / battens, timber noggins should be installed.
- Each sheet of insulated plasterboard should be lightly butted, with fixings located no less than 10 mm from the bound edges of the sheet.
- *Kingspan Kooltherm*® K118 Insulated Plasterboard should be cut approximately 5 mm short of the floor to ceiling height.
- Sheets of *Kingspan Kooltherm*® K118 Insulated Plasterboard should be located centrally over the timber studs / battens and fixed using either drywall screws at 300 mm centres (or 200 mm at external corners), or large headed galvanised clout nails at 150 mm centres. Each sheet of insulated plasterboard should be lightly butted.
- When installing sheets onto timber, fixings should be long enough to allow minimum 25 mm penetration of the timber frame or minimum 22.5 mm penetration of the the timber battens. Fixings should not penetrate through the battens.
- Fixings should be driven straight, with the heads embedded just below the surface of the plasterboard.
- Care should be taken not to overdrive nails / screws.
- The perimeter of the *Kingspan Kooltherm*® K118 Insulated Plasterboard and the 5 mm clearance gap at the base of the wall should be sealed with a flexible sealant or equivalent.

To Metal Wall Liner Systems

- This method may be used on any dry, stable constructions capable of supporting the stand-off brackets, tracks and associated fixings. It can be used to correct substantial substrate irregularities, or where a larger cavity is required to accommodate services.
- Because metal framing systems are proprietary, sitework guidance should be sought from the framing system manufacturer.
- However, in the absence of any other guidance, the instructions laid out below may be followed.
- The maximum undulation on the wall or service protrusion should be measured to determine the required cavity depth.
- Guidelines should be marked out on the floor and ceiling to indicate where the metal tracks will be positioned.
- The metal tracks should be fixed to the floor, ceiling and perimeters at a maximum of 600 mm centres using appropriate fixings for the proprietary system.
- Vertical guidelines should be marked out on the wall at a maximum 600 mm centres to indicate the position of the lining channels. Horizontal marks should also be made at 800 – 900 mm vertical centres (see manufacturers details for specific dimensions) to indicate the fixing points for the individual stand-off brackets. Brackets should be fixed using appropriate fixings.
- The lining channels should be fitted and fixed into the metal tracks at ceiling and floor level at a maximum of 600 mm centres, in line with the stand-off bracket positions, using appropriate fixings for the proprietary system, extending if required.
- Bracket legs on the stand-off brackets should be bent forward. Screws should then be inserted through holes in the brackets and fixed to the lining channels using appropriate fixings, such as 13 mm wafer headed drywall screws or jack point screws. Bracket legs can then be bent back to sit clear of the channel face.
- At internal angles or corner, a lining channel or track should be positioned tight into the corner to provide support for the lining.
- Fixing straps or fixing T's should be used to secure unsupported board joints. Metal channels or tracks should also be positioned around the perimeter of openings to support the board.
- *Kingspan Kooltherm*® K118 Insulated Plasterboard should be cut approximately 5 mm short of the floor to ceiling height.

Sitework

- **Kingspan Kooltherm® K118 Insulated Plasterboard** should be located centrally over the metal lining channels and fixed using self-tapping drywall screws at 300 mm centres (or 200 mm at external corners). Each sheet of insulated plasterboard should be lightly butted.
- Fixings should be located no less than 10 mm from bound edges of the sheet, and be long enough to allow minimum 10 mm penetration of the metal.
- Fixings should be driven straight, with the heads embedded just below the surface of the plasterboard.
- Care should be taken not to overdrive screws.
- The perimeter of the **Kingspan Kooltherm® K118 Insulated Plasterboard** and the 5 mm clearance gap at the base of the wall should be sealed with a flexible sealant or equivalent.

Adhesive Bonding

Drywall Adhesive Dab Bonding

- This method is suitable for use on brick, block or concrete cavity or rendered solid walls, which are dry, stable and free from moisture penetration.
- This method is not suitable for use directly on non-rendered solid masonry walls where there is a risk of moisture penetration, or on timber or steel frame construction.
- The cavity formed by the dabs can be used to incorporate services less than 25 mm in depth. Alternatively, minimum chasing of the background will be required.
- Minor irregularities of the substrate can be corrected within the dab depth. Typically, gypsum based adhesive should be applied in dabs of 10 – 25 mm thickness, therefore the existing substrate should not exceed a 15 mm tolerance from the high spot of the background to either end of the wall.
- A bonding agent may be required on the substrate to reduce suction or improve mechanical key. This should be applied in continuous bands to correspond with the drywall adhesive dab or band locations.
- A total distance of 10 mm plus the thickness of the **Kingspan Kooltherm® K118 Insulated Plasterboard** should be allowed for from the wall's high point. A line should then be drawn across the floor. This should be plumbed for alignment before transferring the line to the ceiling and extending the line to the room corners. Guidelines should also be marked out vertically on the walls at 1,200 mm horizontal centres to indicate where the edges of the **Kingspan Kooltherm® K118 Insulated Plasterboard** should finish.

- There are many suitable adhesives that can be used. Please see Table 1 for details.

Suitable Adhesive	Bonding Agent to be Applied to the Insulation	No. of Appropriate Secondary Fixings Required
Knauf Drywall Plasterboard Adhesive	No	2
GTEC Universal Bonding Compound	Yes	6
British Gypsum Gyproc DriWall Adhesive	Yes	6
All Other Brands Not Listed	Yes	6

Table 1 – Adhesive Options for Drywall Adhesive Dab Bonding

- The drywall adhesive should be appropriate for use on the intended masonry substrate. Advice should be sought from the drywall adhesive manufacturer for its recommended system.
- **Kingspan Kooltherm® K118 Insulated Plasterboard** should be cut approximately 15 mm short of the floor to ceiling height.
- Some adhesives will require an additional bonding agent to be applied to the insulation (see Table 1). Suitable bonding agents such as Thistle Bond-It or PVAc should be used. PVAc bonding agents should conform to BS 5270-1: 1989 (Bonding agents for use with gypsum plasters and cement. Specification for polyvinyl acetate (PVAc) emulsion bonding agents for indoor use with gypsum building plasters).
- If required, one coat of undiluted bonding agent is to be applied with a roller onto the surface of the insulation foil facer on the reverse of the **Kingspan Kooltherm® K118 Insulated Plasterboard**, in bands of minimum 150 mm wide around the perimeter and also down the centre of the board (to coincide with the positioning of the dabs of adhesive) (see Figure 5).

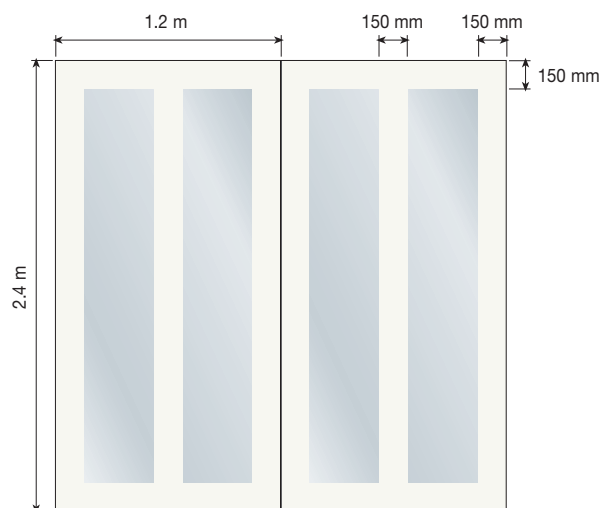

Figure 5 – A Bonding Agent Should be Applied Around the Perimeter and Down the Centre of the Board

- A continuous band of drywall adhesive is applied around the perimeter of each wall and around any openings or services, in order to support the insulation board edges and act as a fire stop / cavity barrier if required.
- The adhesive adjacent to the board joints should be applied approximately 25 mm in from the edge of the boards to avoid bridging the joint.
- Adhesive dabs are generally applied to the background in three vertical rows, but a minimum of 20% of the insulated plasterboard area should be covered with adhesive. Each drywall adhesive dab should be 50 to 75 mm wide and approximately 250 mm long, positioned vertically at approximately 300 mm centres and horizontally at 600 mm centres.

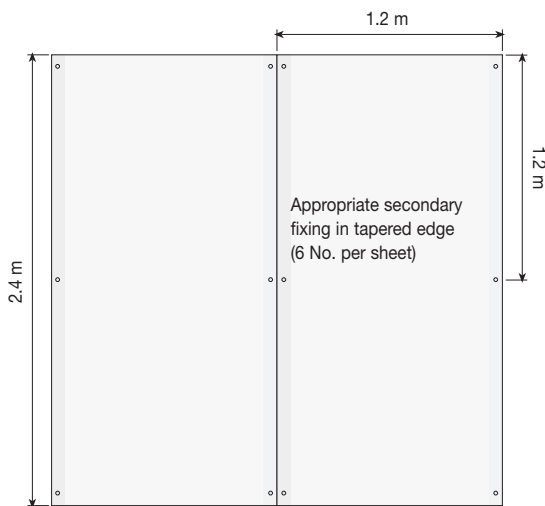

Figure 6 – Appropriate Secondary Fixing Pattern for Drywall Adhesive Dab Bonding Using 6 Additional Fixings (See Figure 7 for the Appropriate Secondary Fixing Pattern when using 2 Additional Fixings)

- Fixings should be long enough to allow minimum 25 mm penetration into the fair faced masonry.
- Fixings should be driven straight, with the heads embedded just below the surface of the plasterboard.
- Care should be taken not to overdrive screws.
- Each sheet of insulated plasterboard should be lightly butted.
- The perimeter of the **Kingspan Kooltherm® K118 Insulated Plasterboard** should be sealed. The 15 mm clearance gap at the base of the wall should be sealed with a combination of flexible polyurethane foam and flexible sealant or equivalent.

Acrylic Sealant / PU Foam Adhesive Bonding

- This method is suitable for use on flat brick, block or concrete cavity or rendered solid walls, which are dry, stable and free from moisture penetration.
- This method is also suitable for use on linings such as lath and plaster, plaster or plasterboard, providing the existing structure is dry, stable and free from moisture penetration.
- This method is not suitable for use directly on non-rendered solid masonry walls where there is a risk of moisture penetration.
- In order to provide sufficient space for services, the background will need to be chased out, unless the services exist within the wall or are contained within the lining framework cavity. Existing services should be assessed to determine any alterations that may need to be made, for example relocating sockets and switches.
- The existing substrate should be within a 5 mm tolerance when measured with a 2,000 mm straight edge. A total distance of 2-3 mm plus the thickness of the **Kingspan Kooltherm® K118 Insulated Plasterboard** should be allowed for from the wall's high point. A line should then be drawn across the floor. This should be plumbed for alignment before transferring the line to the ceiling and extending the line to the room corners.
- Guidelines should be marked out on the walls at 1,200 mm horizontal centres to indicate where the edges of **Kingspan Kooltherm® K118 Insulated Plasterboard** should finish.
- **Kingspan Kooltherm® K118 Insulated Plasterboard** should be cut approximately 15 mm short of the floor to ceiling height.
- There are many suitable adhesives that can be used. Please see Table 2 for details.

Fixing Method	Suitable Adhesive	Bonding Agent to be Applied to the Insulation	No. of Appropriate Secondary Fixings Required
Acrylic Sealant Adhesive	Firetherm Intumastic ADL	No	2
Acrylic Sealant Adhesive	Geocel QUICKGRIP SUPERGRAB	No	2
PU Foam Adhesive	Dow INSTA-STIK MP	No	2

Table 2 – Adhesive Options for Acrylic Sealant / PU Foam Adhesive Bonding

Sitework

- Acrylic sealant adhesive should be gun-applied to the wall or back of the board in blobs at 300 mm centres, horizontally and vertically.
- PU foam adhesive should be gun-applied to the wall or back of the board in continuous beads 20 – 25 mm wide. A minimum of 3 vertical beads should be applied per board (unless otherwise stated by the PU foam adhesive manufacturer). A continuous bead of PU foam adhesive should also be applied horizontally at the top and the bottom of the board.
- The adhesive adjacent to the board joints should be applied approximately 25 mm in from the edge of the boards to avoid bridging the joint.
- The boards should be lifted tight to the ceiling using a foot-lifter and supported by the packing strips until the adhesive sets. If the wall height exceeds 2,400 mm, start from the bottom of the wall, working upwards, to allow boards to be held on the lower level of the wall and prevent any boards from sliding down.
- The boards should then be tapped back to align with the predetermined guidelines on the floor and ceiling. The use of a spirit level is recommended to provide a vertical plumb finish.
- Once the adhesive has set, appropriate secondary fixings should be used in addition to the adhesive.
- These are normally applied at a rate of 2 No. per sheet, 15 mm in from the edge of the sheet, after the adhesive has set (see Figure 7).

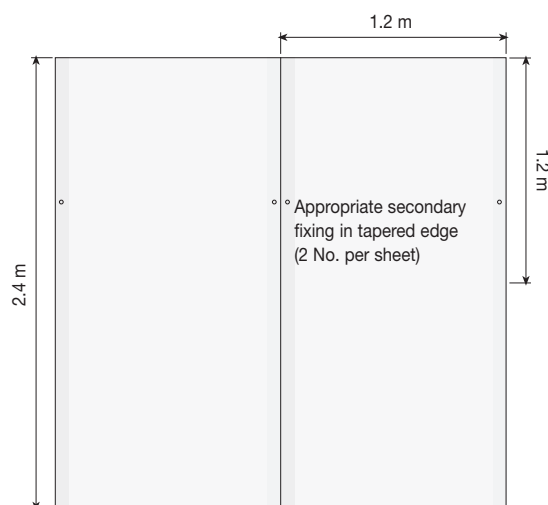

Figure 7 – Appropriate Secondary Fixing Pattern for Acrylic Sealant / PU Foam Adhesive Bonding

- It is recommended that appropriate secondary fixings are positioned in the tapered edge of the sheets so that they are covered when the board is finished (e.g. joints taped and 3 mm skim coating). The number of appropriate secondary fixings is specified in Table 2.
- Fixings should be long enough to allow minimum 25 mm penetration into the masonry (excluding plaster). If a lining exists, fixings should be long enough to allow minimum 25 mm into the timber or 10 mm into the metal framework (excluding plasterboard or lath and plaster).
- Fixings should be driven straight, with the heads embedded just below the surface of the plasterboard.
- Care should be taken not to overdrive screws.
- Each sheet of insulated plasterboard should be lightly butted.
- The perimeter of the *Kingspan Kooltherm*® K118 Insulated Plasterboard should be sealed. The 15 mm clearance gap at the base of the wall should be sealed with a combination of flexible polyurethane foam and flexible sealant or equivalent.

To Timber Joists or Rafters

- Sheets of **Kingspan Kooltherm® K118 Insulated Plasterboard** may be used to line ceilings (see Figure 8).

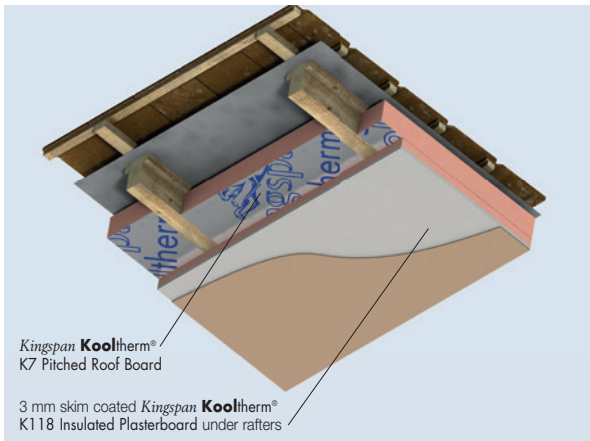

Figure 8 – Mechanically Fixed to Timber Rafters with **Kingspan Kooltherm® K7 Pitched Roof Board** Between Rafters

- Sheets must always be placed with the long edge running across the joists or rafters, and all edges must be supported.
- Where joints between sheets of insulated plasterboard are unsupported by the timber joists / rafters, timber noggins should be installed.
- Each sheet of insulated plasterboard should lap joists / rafters / noggins by 19 mm (min.) at sheet joints.
- Sheets should be fixed using either drywall screws at 230 mm centres, or large-headed galvanized clout nails placed at 150 mm centres.
- Each sheet of insulated plasterboard should be lightly butted, with fixings located no less than 10 mm from the bound edges of the sheet. Fixings should be long enough to allow a minimum 25 mm penetration of the timber.
- Fixings should be driven straight, with the heads embedded just below the surface of the plasterboard.
- Care should be taken not to overdrive nails / screws.
- The perimeter of the **Kingspan Kooltherm® K118 Insulated Plasterboard** should be sealed with a flexible sealant or equivalent.

Fixing Heavy Internal Fittings

- Suitable mechanical fixings should be used for heavy internal fittings (kitchen units, shelving etc), to ensure the load is applied direct to the supporting wall and not to the **Kingspan Kooltherm® K118 Insulated Plasterboard**.

For details on fixings refer to:

Tiger Fixings +44 (0) 8456 038 877
www.tigerfixings.com

MAK Fasteners +353 (0) 1 451 99 00
www.makfasteners.com

Fischer Fixings +353 (0) 1 642 6700
www.fischer.ie

- Alternatively, where there are to be extensive heavy internal fittings, the construction outlined in Figure 9 can be adopted.

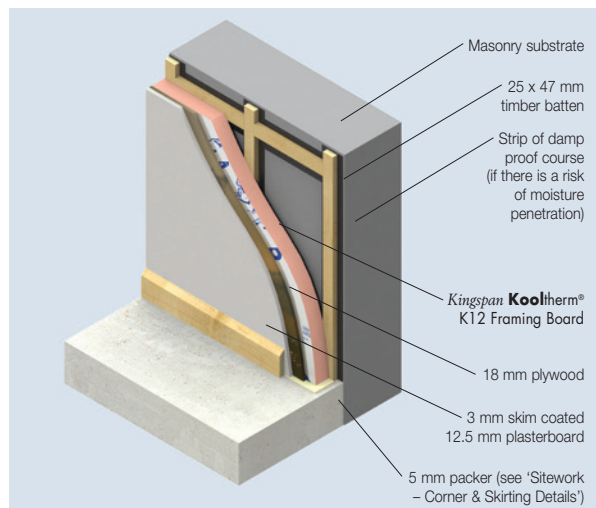

Figure 9

- Vertical timber framing studs / battens should be set at maximum 600 mm horizontal centres.
- If fixing to battens, they should be mechanically fixed to the wall, and comprise 25 x 47 mm (min.) treated softwood, backed with a strip of damp proof course (DPC).
- **Kingspan Kooltherm® K12 Framing Board** should be cut approximately 5 mm short of the floor to ceiling height.
- Where insulation board joints are unsupported by the timber framing studs / battens, timber noggins should be installed.

Sitework

- Each insulation board should lap timber framing studs / battens / noggins by 19 mm (min.) at board joints.
- Boards of *Kingspan Kooltherm*® K12 Framing Board should be temporarily fixed / nailed to timber framing studs / battens.
- 18 mm plywood should then be fixed through insulation boards to the timber framing studs / battens, using either drywall screws at 300 mm centres, or large headed galvanised clout nails at 150 mm centres.
- When fixing plywood through the insulation boards onto timber battens, fixings should be located no less than 10 mm from the bound edges of the sheets, and be long enough to allow minimum 22.5 mm penetration of the timber. Fixings should not penetrate through the battens.
- When fixing plywood through the insulation boards onto a timber frame, fixings should be located no less than 10 mm from the bound edges of the sheets, and be long enough to allow a minimum 25 mm penetration of the timber.
- Fixings should be driven straight, with the heads embedded just below the surface of the plywood.
- 12.5 mm plasterboard is then fixed to the plywood, using either drywall screws at 300 mm centres, or large headed galvanised clout nails at 150 mm centres.
- Fixings should be driven straight, with the heads embedded just below the surface of the plasterboard.
- Care should be taken not to overdrive nails / screws.
- The 5 mm clearance gap at the base of the wall should be sealed with a flexible sealant or equivalent.
- Heavy fittings can be fixed through the plasterboard directly to the plywood.

Corner & Skirting Details

- For external corners (including reveals), the lining should run past the corner and the insulating backing of *Kingspan Kooltherm*® K118 Insulated Plasterboard should be cut back to create a junction (see Figures 10 & 12). Sheets should be cut and rebated to allow a plasterboard / plasterboard joint at the angle (see Figures 10 & 11).
- Ensure sheets are lightly butted and air gaps minimised to reduce the risk of cold bridging (see Figures 10 & 12). Any air gaps should be sealed with flexible sealant or equivalent, or a combination of flexible polyurethane foam and flexible sealant or equivalent.

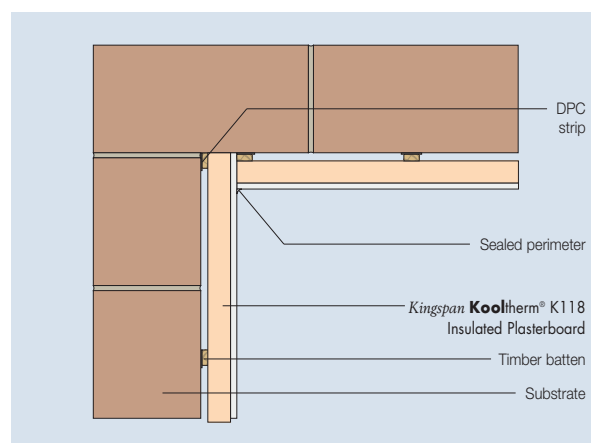

Figure 10 – Internal Corner Detail

- For mechanically fixed applications, a 5 mm packer should be used at the base of the wall to provide a level surface from which to build up the boards.
- For adhesively bonded applications, a 15 mm packer should be used at the base of the wall to provide a level surface from which to build up the boards.
- The packer should be replaced with a flexible / sealant or equivalent (for 5 mm gaps), or with a combination of flexible polyurethane foam and flexible sealant or equivalent (for 15 mm gaps) (see Figure 11).

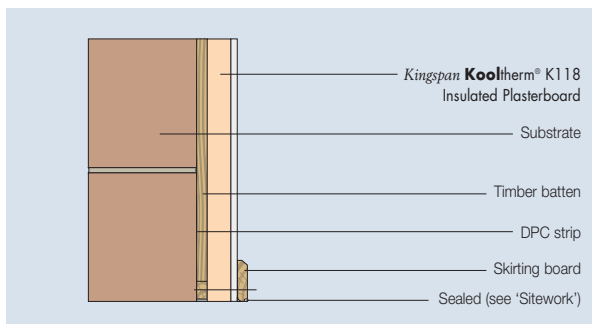

Figure 11 – Packer and Skirting Detail

Window / Door Reveals, Separating / Internal Walls & Soffit / Head Details

- Reveal lining can be either bonded in place or mechanically fixed. Secondary fixings should be used when bonding the lining in place.
- If the main wall lining has been installed using timber battens / studs or metal framing, then the reveal linings can still be bonded, providing the secondary fixings are installed into the timber battens / studs or metal studs, either side of the opening and to the head and sill of the opening.
- A 32.5 mm sheet of *Kingspan Kooltherm® K118 Insulated Plasterboard* should be used to line the window or door reveals. Where the depth of the window or door frames does not allow for this, the reveal can be cut back or the existing lining can be removed.
- The junction of the external wall and separating / internal wall should also be insulated with 32.5 mm (min.) of *Kingspan Kooltherm® K118 Insulated Plasterboard*, for a minimum distance of 400 mm back from the external all lining.

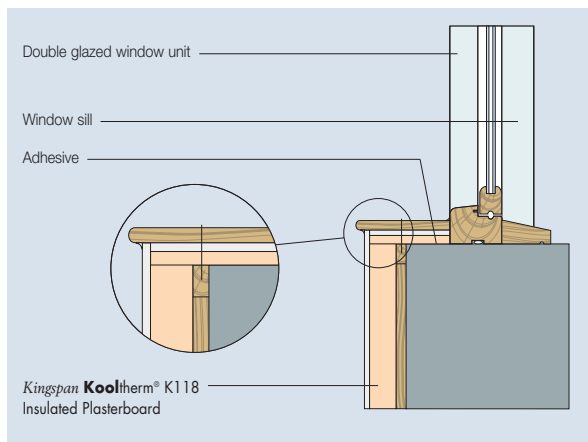

Figure 12 – Insulated Reveal and External Corner

Finishing

- To avoid air leakage, any penetrations through the insulation (electrical sockets, plumbing and wiring etc) should be sealed with flexible sealant or equivalent, or a combination of flexible polyurethane foam and flexible sealant or equivalent.
- Any remaining gaps between boards / sheets of insulation should be filled with flexible sealant or equivalent, or a combination of flexible polyurethane foam and flexible sealant or equivalent.
- Tapered edged boards allow the employment of standard dry-lining techniques.
- Plasterboard tape should be employed at all board joints, and a plaster skim finish applied.
- The skimming should be carried out in accordance with the specified plaster manufacturer's instructions, particularly in relation to the need to allow thorough drying of the plaster prior to decoration.

Sitework

General

Cutting

- Cutting should be carried out either by using a fine toothed saw, or by using a sharp knife to cut through the insulation and paper backing of the plasterboard, then snapping the sheet face down over a straight edge and cutting the paper facing of the plasterboard on the other side.
- Ensure accurate trimming to achieve close butting joints and continuity of insulation.

Availability

- **Kingspan Kooltherm® K118 Insulated Plasterboard** is available through specialist insulation distributors and selected builders' merchants throughout the UK and Ireland.

Packaging and Storage

- The polyethylene packaging of Kingspan Insulation products, which is recyclable, should not be considered adequate for outdoor protection.
- Ideally sheets should be stored inside a building. If, however, temporary outdoor storage cannot be avoided then the sheets should be stacked flat on a level base, clear of the ground, and completely protected from inclement weather by use of an opaque polythene sheet or weatherproof tarpaulin. Sheets that have been allowed to get wet should not be used.

Health and Safety

- Kingspan Insulation products are chemically inert and safe to use.
- A Safety Information Data Sheet for this product is available from the Kingspan Insulation website www.kingspaninsulation.co.uk/safety or www.kingspaninsulation.ie/safety.

Please note that the reflective surfaces on this product are designed to enhance its thermal performance. As such, they will reflect light as well as heat, including ultraviolet light. Therefore, if this product is being installed during very bright or sunny weather, it is advisable to wear UV protective sunglasses or goggles, and if the skin is exposed for a significant period of time, to protect the bare skin with a UV block sun cream.

The reflective facings used on this product can be slippery when wet. Therefore, it is recommended that any excess material should be contained to avoid a slip hazard.

Warning – do not stand on or otherwise support your weight on this product unless it is fully supported by a load bearing surface.

Product Details

The Front Facing

The front facing of **Kingspan Kooltherm® K118 Insulated Plasterboard** is an A2,s1,d0 Euroclass tapered edge gypsum based plasterboard which readily accepts dry-jointing materials and plaster skim.

The Core

The core of **Kingspan Kooltherm® K118 Insulated Plasterboard** is a premium performance rigid thermoset fibre-free phenolic insulant manufactured with a blowing agent that has zero Ozone Depletion Potential (ODP) and low Global Warming Potential (GWP).



The Reverse Face

The reverse facing of **Kingspan Kooltherm® K118 Insulated Plasterboard** is a low emissivity composite foil, autohesively bonded to the insulation core during manufacture. This reflective, low emissivity surface improves the thermal resistance of any unventilated cavity adjacent to the product.

Standards & Approvals

Kingspan Kooltherm® K118 Insulated Plasterboard is manufactured to the highest standards under a management system certified to ISO 9001: 2015 (Quality Management Systems. Requirements), ISO 14001: 2015 (Environmental Management Systems. Requirements), BS OHSAS 18001: 2007 (Occupational Health & Safety Management Systems. Requirements) and ISO 50001: 2011 (Energy Management Systems. Requirements with guidance for use).

The use of **Kingspan Kooltherm® K118 Insulated Plasterboard** is covered by BBA Certificate 16/5299 and by LABC Registered Details Certificate No. EWWS545J.



Standard Dimensions

Kingspan Kooltherm® K118 Insulated Plasterboard is available in the following standard size:

Nominal Dimension	Availability
Length (m)	2.4
Width (m)	1.2
Plasterboard Thickness (mm)	12.5
Insulant Thickness (mm)	Refer to local distributor or Kingspan Insulation price list for current stock and non-stock sizes.

Compressive Strength

The compressive strength of *Kingspan Kooltherm*® K118 Insulated Plasterboard typically exceeds 100 kPa at 10% compression, when tested to BS / I.S. EN 826: 2013 (Thermal insulating products for building applications. Determination of compression behaviour).

Water Vapour Resistance

Adjusted for the effect of board joints, the non-plasterboard component of the product typically achieves a resistance far greater than 100 MN-s/g, when tested in accordance with BS / I.S. EN 12086: 2013 (Thermal insulating products for building applications. Determination of water vapour transmission properties). For the purposes of calculation of condensation risk, the resistivity of the plasterboard component of the product should be taken as 50 MN-s/g-m.

Durability

If correctly installed, *Kingspan Kooltherm*® K118 Insulated Plasterboard can have an indefinite life. Its durability depends on the supporting structure and the conditions of its use.

Resistance to Solvents, Fungi & Rodents

The insulation core is resistant to short-term contact with petrol and with most dilute acids, alkalis and mineral oils. However, it is recommended that any spills be cleaned off fully before the boards are installed. Ensure that safe methods of cleaning are used, as recommended by the suppliers of the spilt liquid. The insulation core is not resistant to some solvent-based adhesive systems, particularly those containing methyl ethyl ketone. Adhesives containing such solvents should not be used in association with this product. Damaged boards or boards that have been in contact with harsh solvents or acids should not be used.

The insulation core and facings used in the manufacture of *Kingspan Kooltherm*® K118 Insulated Plasterboard resist attack by mould and microbial growth and do not provide any food value to vermin.

Fire Performance

Kingspan Kooltherm® K118 Insulated Plasterboard achieves European Classification (Euroclass) B-s1,d0 when classified to EN 13501-1: 2018 (Fire classification of construction products and building elements. Classification using data from reaction to fire tests).

Kingspan Kooltherm® K118 Insulated Plasterboard, when subjected to EN ISO 5659-2: 2012 (Plastics. Smoke generation. Part 2: Determination of optical density by a single-chamber test), has achieved a mean maximum specific optical density of smoke < 200 in both the presence and absence of a pilot flame at irradiances of 25 and 50 kW/m².

Further details of the fire performance of Kingspan Insulation products may be obtained from the Kingspan Insulation Technical Service Department (see rear cover).

Thermal Properties

The λ -values and R-values detailed below are quoted in accordance with BS / I.S. EN 13166: 2012 + A2: 2016 (Thermal insulation products for buildings. Factory made phenolic foam (PF) products. Specification).

Thermal Conductivity

The thermal conductivity (λ -value) of the plasterboard component of *Kingspan Kooltherm*® K118 Insulated Plasterboard is 0.19 W/m·K.

The thermal conductivity (λ -value) of the insulation core of *Kingspan Kooltherm*® K118 Insulated Plasterboard is 0.018 W/m·K.

Thermal Resistance

Thermal resistance (R-value) varies with the thickness of each component. It is calculated by dividing the thickness of each component (expressed in metres) by its thermal conductivity, followed by adding the resulting figures together. The sum is rounded down to the nearest 0.05 (m²·K/W).

*Product Thickness (mm)	Thermal Resistance (m ² ·K/W)
32.5	1.15
37.5	1.45
42.5	1.70
47.5	2.00
52.5	2.25
57.5	2.55
62.5	2.80
67.5	3.10
72.5	3.35
82.5	3.95
87.5	4.20
92.5	4.50
102.5	5.05
112.5	5.60
122.5	6.15

* Product thickness = insulation thickness + 12.5 mm plasterboard.

NB Refer to local distributor or Kingspan Insulation price list for current stock and non-stock sizes.

Contact Details

Customer Service

For quotations, order placement and details of despatches please contact the Kingspan Insulation Customer Service Department on the numbers below:

- UK – Tel: +44 (0) 1544 388 601
– email: customerservice@kingspaninsulation.co.uk
- Ireland – Tel: +353 (0) 42 979 5000
– email: info@kingspaninsulation.ie

Literature & Samples

Kingspan Insulation produces a comprehensive range of technical literature for specifiers, contractors, stockists and end users.

The literature contains clear user friendly advice on typical design; design considerations; thermal properties; sitework and product data.

For copies please contact the Kingspan Insulation Marketing Department, or visit the Kingspan Insulation website, using the details below:

- UK – Tel: +44 (0) 1544 387 384
– email: literature@kingspaninsulation.co.uk
– www.kingspaninsulation.co.uk/literature
- Ireland – Tel: +353 (0) 42 979 5000
– email: info@kingspaninsulation.ie
– www.kingspaninsulation.ie/literature

Tapered Roofing

For technical guidance, quotations, order placement and details of despatches please contact the Kingspan Insulation Tapered Roofing Department on the numbers below:

- UK – Tel: +44 (0) 1544 387 383
– email: tapered@kingspaninsulation.co.uk
- Ireland – Tel: +353 (0) 42 975 4297
– email: tapered@kingspaninsulation.ie

Technical Advice / Design

Kingspan Insulation supports all of its products with a comprehensive Technical Advisory Service. Calculations can be carried out to provide U-values, condensation / dew point risk, required insulation thicknesses etc...

U-value calculations can also be carried out on the Kingspan Insulation U-value Calculator, available for free online at www.uvalue-calculator.co.uk or downloaded as an App.



The Kingspan Insulation Technical Service Department can also give general application advice and advice on design detailing and fixing etc... Site surveys are also undertaken as appropriate.

The Kingspan Insulation British Technical Service Department operates under a management system certified to the BBA Scheme for Assessing the Competency of Persons to Undertake U-value and Condensation Risk Calculations.



Please contact the Kingspan Insulation Technical Service Department on the numbers below:

- UK – Tel: +44 (0) 1544 387 382
– email: technical@kingspaninsulation.co.uk
- Ireland – Tel: +353 (0) 42 975 4297
– email: technical@kingspaninsulation.ie

General Enquiries

For all other enquiries contact Kingspan Insulation on the numbers below:

- UK – Tel: +44 (0) 1544 388 601
– email: info@kingspaninsulation.co.uk
- Ireland – Tel: +353 (0) 42 979 5000
– email: info@kingspaninsulation.ie

Kingspan Insulation Ltd reserves the right to amend product specifications without prior notice. Product thicknesses shown in this document should not be taken as being available ex-stock and reference should be made to the current Kingspan Insulation price-list or advice sought from Kingspan Insulation's Customer Service Department (see above left). The information, technical details and fixing instructions etc. included in this literature are given in good faith and apply to uses described. Recommendations for use should be verified for suitability and compliance with actual requirements, specifications and any applicable laws and regulations. For other applications or conditions of use, Kingspan Insulation offers a Technical Advisory Service (see above), the advice of which should be sought for uses of Kingspan Insulation products that are not specifically described herein. Please check that your copy of this literature is current by contacting the Kingspan Insulation Marketing Department (see left).



Kingspan Insulation Ltd
Pembridge, Leominster, Herefordshire HR6 9LA, UK
Castleblayney, County Monaghan, Ireland

www.kingspaninsulation.co.uk www.kingspaninsulation.ie